

EN Operating manual

Cold and hot water high-pressure cleaner – electrically heated

e-therm 500 M 18

e-therm 500 M 24

e-therm 603 M 36

e-therm 873 M 48



Operating manual

EN

Cold and hot water high-pressure cleaner – electrically heated

e-therm 500 M 18

e-therm 500 M 24

e-therm 603 M 36

e-therm 873 M 48

Operating manual!

This manual is a translation of the original manual. Read and conform safety instructions before use! Technical data will be found in the Spare parts list. Please be aware that the spare part list is part of the operating manual. Keep both leaflets for later use or any subsequent owners.

Dear customer,

we would like to congratulate you on the purchase of your new high-pressure cleaner and thank you for your confidence in our products!

Your choice has fallen on an absolute quality product!
Kränzle high-pressure cleaners are characterized by their high suitability for everyday use.

Highest precision and dimensional accuracy in addition to a technology package consisting of a multitude of details mark the difference when it comes to performance, safety and durability.

In order to facilitate handling of the high-pressure cleaner, the following pages are intended to further explain its use. The illustrations may be subject to deviation depending on the type of equipment or accessory of high-pressure cleaner purchased by you.

Contents	4
Explanatory symbols	5
Safety notes	8
Description of high-pressure cleaner	12
General rules	18
Functional details	22
Putting into operation	29
Direct suction	35
Taking out of operation	36
Particular rules, directives and inspections	37
Care and Maintenance	37
Small repairs - do it yourself	38
Kränzle accessories	46
EU Declaration of Conformity	48
Warranty	49
Inspection reports	50
Kränzle Final report	52

Explanatory symbols used in the operating manual



Failure to observe this note may entail environmental damage.



Note on the use of the high-pressure cleaner that failure to adhere to the instructions may cause excessive wear or total breakdown of the e-therm-series.



Warning!
Failure to observe this note may result in serious injuries!

Explanatory symbols affixed to the high-pressure cleaner



In case of improper use, the high-pressure jets can be very dangerous. Do not direct high-pressure jet at persons, animals or active electrical equipment or the high-pressure cleaner itself.



The high-pressure cleaner may not be connected directly to the public drinking water supply network.



Risk of burns due to hot surfaces!



Warning! Attention high voltage.
Prior to opening high-pressure cleaner the main switch must be set "OFF" and the mains plug must be pulled out.



Products marked with this symbol may contain constituents posing a risk to health or the environment if incorrectly disposed of. These products must never be disposed of as household waste.

Explanatory symbols affixed on the packaging



This symbol denotes recyclable packaging materials which must not be disposed of as household waste. Information on proper disposal will be gathered from the recycling directives issued by your local authority.

Explanatory symbols used on the control panel

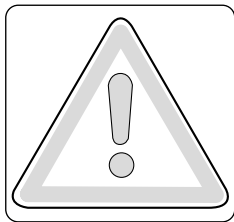

Attention: For safety reasons switch off main switch after completing the washing procedure (= supply isolation)

Prior to putting the machine into operation make sure that all safety instructions be observed.

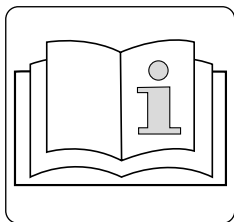

Prior to putting the machine into operation make sure that all safety instructions be observed.

Explanatory symbols used on the short instruction manual

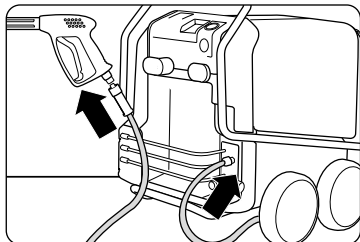

Step 1:
Screw high-pressure hose down and pressure-tight using safety trigger gun and lance.

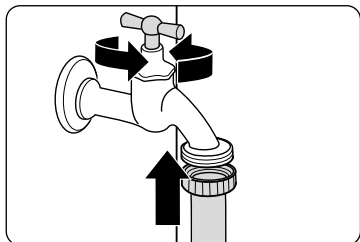

Step 2:
Connect water hose to water inlet.
Open water tap.

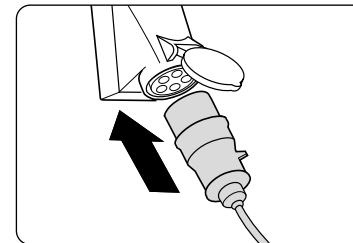

Step 3:
Connect to circuit (see technical data).

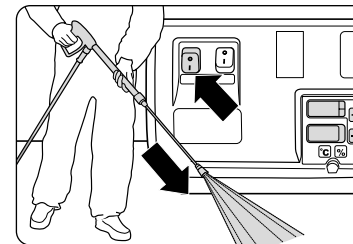

Step 4:
Usage as a cold water high-pressure cleaner.
Switch on high-pressure cleaner at main switch with opened safety trigger gun.
Start with cold water cleaning process.

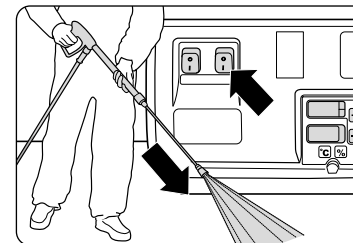

Step 5:
Usage as a hot water high-pressure cleaner.
Switch on high-pressure cleaner at heater switch with opened safety trigger gun. Start with hot water cleaning process.

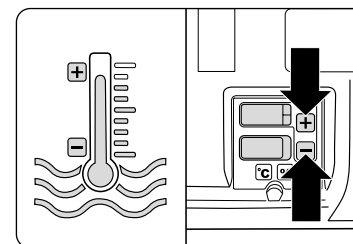

Controlling the temperature
Set the desired temperature at the digital thermostat by pushing the plus and minus buttons (Min. temperature 40 °C). Settings are possible in cold water and hot water operation.

User operating the high-pressure cleaner should wear the necessary protective clothing, i.e. waterproof clothing, rubber boots, safety goggles, ear protection headwear etc. It is prohibited to use the high-pressure cleaner in close vicinity to people lacking suitable protective clothing.

If noise exceeds the maximum allowed levels, users and others in the vicinity must wear suitable ear protection.

Use of high-pressure cleaners may result in aerosols being generated. An aerosol is a mixture of floating solid or liquid particles in a gas. Inhaling aerosol particles may cause damage to health. Employers are under obligation to carry out a hazards assessment in order to determine the necessary protective measures to prevent inhalation of aerosols as governed by the surface due to be cleaned in each case. Respiratory masks, Class FFP 2 or higher, are suitable for protection against aqueous aerosols.

Whenever the high-pressure cleaner is left unattended, the mains disconnect switch must always be switched off.

Do not spray against matter containing asbestos or other hazardous substances!

Never spray flammable liquids or liquids containing solvents such as paint thinners, petrol, oil or similar liquids! Explosion hazard due to spraying such materials!

Due to the high-pressure jet, damage may occur on the objects to be cleaned, e.g. car tires; therefore, a minimum distance of 30 cm is to be kept!

Prior to putting the high-pressure cleaners into operation, check its components (High-pressure hose, power supply cables, safety trigger gun) for any damage. Replace defect or damaged components!

Only use high-pressure hoses, couplings and fittings recommended by Kränzle. Only these accessories ensure safety of the equipment.

If use is made of an extension cable, this must be suitable for outdoor use. In addition care needs to be taken to ensure that the cable is kept dry and that it is situated above the ground. We recommend the use of a cable drum capable of keeping the socket at least 60 mm above the ground.

Replacement of the power supply cables is only permitted by use of an original power supply cable of the manufacturer and must be performed by a qualified electrician.

Safety devices serve to protect the user and must never be de-activated or their function bypassed.

The high-pressure cleaner is to be properly used. The user is required to adhere to local requirements and to watch out for the persons in the danger zone!

If used in elevated positions where there is a risk of the unit falling to the ground, it must be secured against rolling away or tipping over.

The high-pressure cleaner is not designed for use by persons with restricted physical, sensory or mental abilities (including children)!

Some parts inside the machine, all metal parts of trigger gun with safety catch and lance are hot during hot water. Keep all hoods and protective covers closed during operation and never touch any metal parts of gun or lance without wearing appropriate protective gloves.

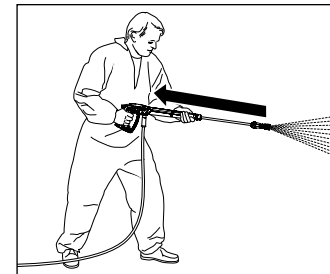

When using high-pressure water for cleaning, make sure that there is a clearly noticeable recoil effect on the lance. Therefore ensure a firm footing (see technical data).

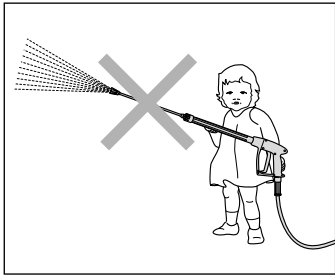

Never allow children or untrained persons to use the high-pressure cleaner or to play with it! Children must be kept under supervision to prevent them from playing with the equipment.

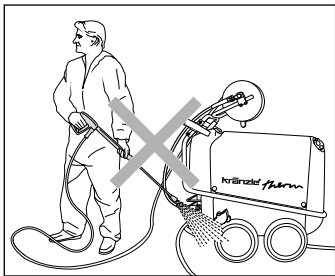

Never direct the high-pressure jet at the high-pressure cleaner itself! The high-pressure cleaner may not be placed within reach of the high-pressure jet spray mist!

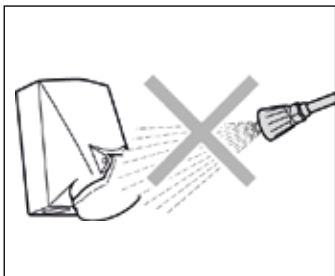

Never direct the high-pressure jet at power sockets or any other electrical installations! Within the working area, all live parts are to be protected from both water jet and spray mist.

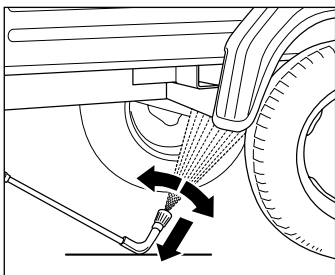

Always pay attention to the underbody lance resting on the surface! Bear in mind when using a curved or angled spraying lance that there is a significant amount of torque in the recoil! (The underbody lance is available as optional accessory).

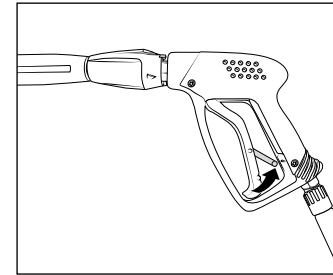

Apply the safety catch on the safety trigger gun after each use in order to prevent unintentional spraying!

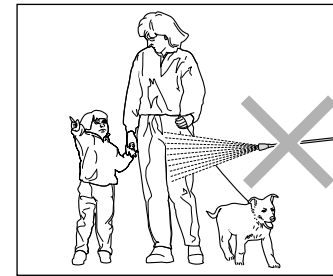

Never direct the high-pressure jet at people or animals! Never direct the high-pressure jet at yourself or other persons, not even to clean clothing or shoes.

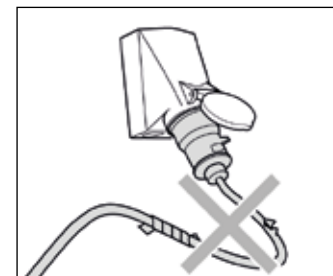

Only use a power supply cable in perfect working order! Do not damage or improperly repair the power cable (tearing, squeezing, running over, ...).

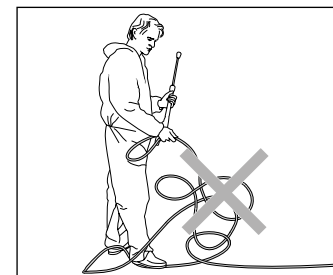

Never pull the high-pressure hose if it has formed kinks or "nooses"! Never pull the high-pressure hose over sharp edges!

Design: e-therm-series without hose drum

The e-therm is a mobile high-pressure cleaner with an advanced arrangement system. Please see construction scheme for more details.

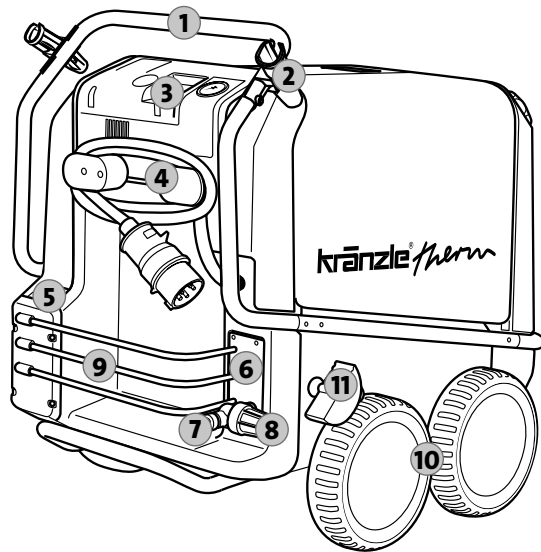

1. Ergonomically shaped handle
2. Holder for trigger gun with safety catch with lanc
3. Digital operating panel (see page 16)
4. Cable reel for the power supply cable
5. Storage for trigger gun with safety catch and lances
6. Pump outlet / high-pressure hose connection
7. Feed line water inlet, water hose connection
8. Water inlet filter
9. Storage bin for accessories
10. Integrated trolley takes rough ground in its stride
11. Locking brake

This is what you have purchased: e-therm-series without hose drum

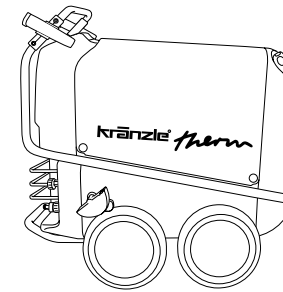

1. Kränzle high-pressure cleaner
e-therm 500 M 18
e-therm 500 M 24
e-therm 603 M 36
e-therm 873 M 48

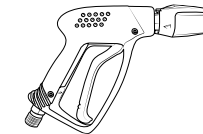

2. Trigger gun with safety catch and plug coupling



3. Stainless steel lance with flat jet nozzle and quick release coupling

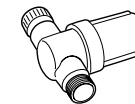

4. Water inlet filter

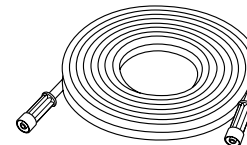

5. High-pressure hose



6. Operating manual
Spare parts list

Design: e-therm-series with hose drum

The e-therm is a mobile high-pressure cleaner with an advanced arrangement system. Please see construction scheme for more details.

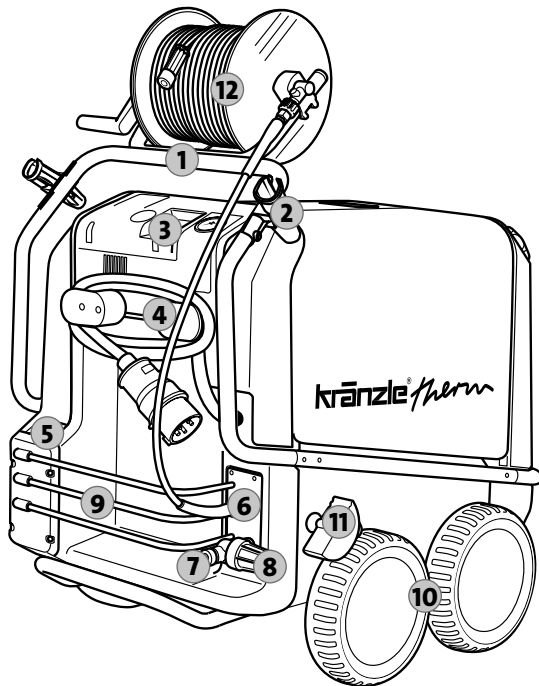

1. Ergonomically shaped handle
2. Holder for trigger gun with safety catch with lanc
3. Digital operating panel (see page 16)
4. Cable reel for the power supply cable
5. Storage for trigger gun with safety catch and lances
6. Pump outlet / high-pressure hose connection
7. Feed line water inlet, water hose connection
8. Water inlet filter
9. Storage bin for accessories
10. Integrated trolley takes rough ground in its stride
11. Locking brake
12. Hose drum with 20 m steel weave high-pressure hose

This is what you have purchased: e-therm-series with hose drum

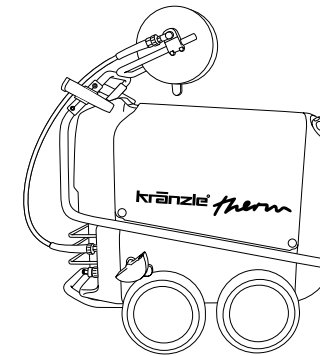

1. Kränzle high-pressure cleaner
e-therm 500 M 18
e-therm 500 M 24
e-therm 603 M 36
e-therm 873 M 48

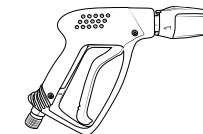

2. Trigger gun with safety catch and plug coupling

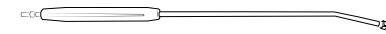

3. Stainless steel lance with flat jet nozzle and quick release coupling

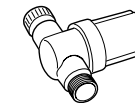

4. Water inlet filter



5. Operating manual
Spare parts list

Construction: Operating panel

The e-therm-series provides a clear operating panel. Please see construction scheme for more details.

- | | |
|-------------------------------------|--|
| 1. Master switch (appliance ON-OFF) | 5. Digital thermostat for adjusting water temperature |
| 2. Heating switch (burner ON/OFF) | 6. Heating coil switch
48 kW → 24 kW
(only for e-therm 873 M 48) |
| 3. Short operating manual | |
| 4. Pressure gauge (water pressure) | |

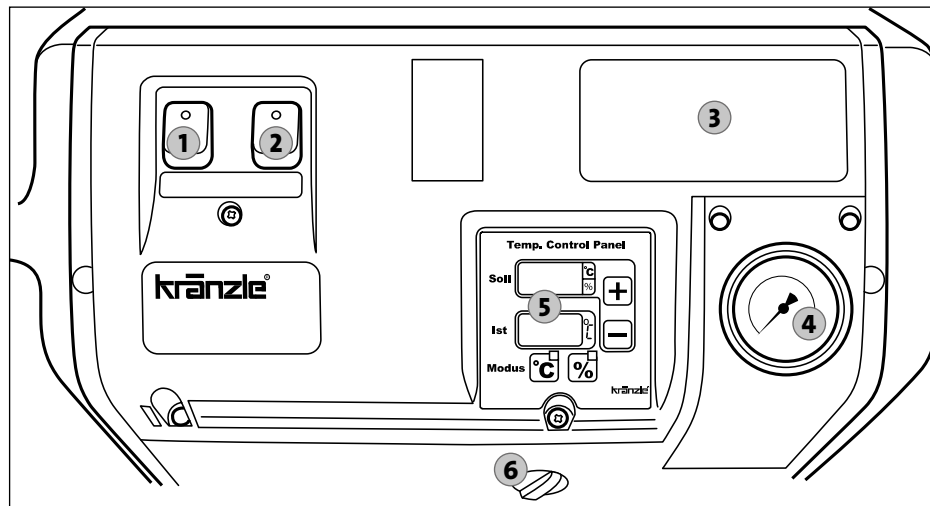

Construction: Interior fittings

The devices of the e-therm-series are cold and hot water high-pressure cleaners. They offer many functions and electronics inside the high-pressure cleaners. Please see construction scheme for more details.

- | | |
|--|--|
| 1. Pump head made of special brass | 5. Heating coil |
| 2. Infinitely variable pressure and quantity regulation | 6. Circuit box heating |
| 3. Oil drain hose | 7. Connecting hose between high-pressure pump and water tank
(all types except e-therm 500 M 18 and e-therm 500 M 24) |
| 4. Water tank (all types except e-therm 500 M 18 and e-therm 500 M 24) | |

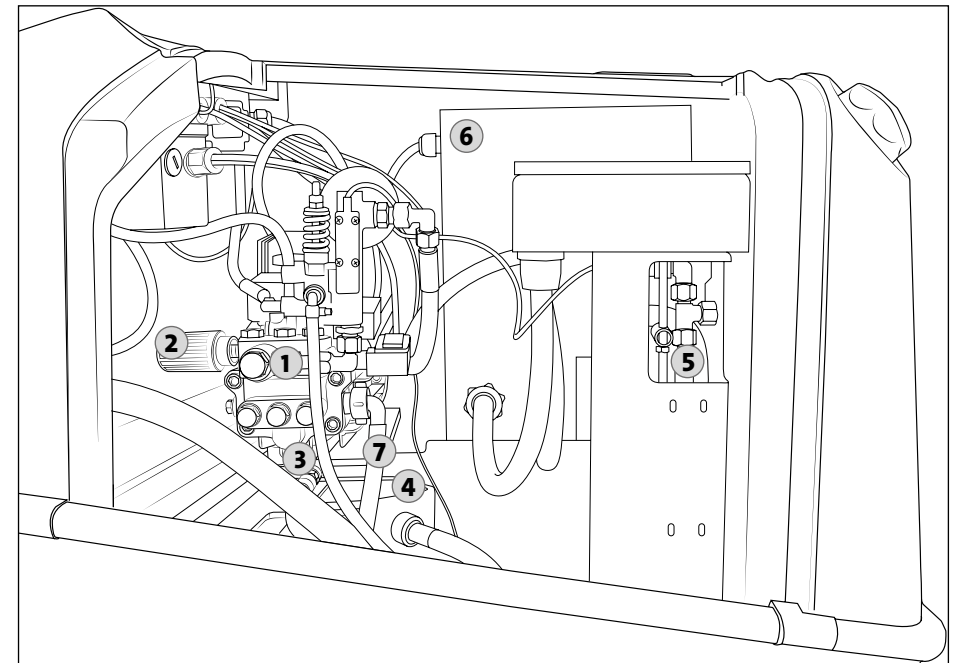

Intended use

This high-pressure cleaner is to be used solely for high-pressure water jet cleaning applications without detergents or low-pressure cleaning work with detergents (e.g. with a foam injector or washing brush).



Environmental, refuse disposal and water protection regulations must be observed!

Inspections

The high-pressure cleaner was finally inspected by the company Kränzle (refer to Kränzle final report).

The high-pressure cleaner must be inspected according to the "Guidelines for Liquid Spray Devices" at least once every 12 months by a qualified person, to ensure that continued safe operation is guaranteed. The results of the inspection are to be recorded in writing (see "Inspection reports" in these operating manual).



High-pressure cleaners used for commercial purposes have to be checked by a qualified person at least every 12 months!



The owner is to ensure that all safety-relevant components are in a serviceable condition before the high-pressure cleaner is used.

Accident prevention

The high-pressure cleaner is designed for accidents to be impossible if used correctly. The user is to be notified of the risk of injury from hot machine parts and the high-pressure jet. The "Guidelines for Liquid Spray Devices" must be complied with.

Oil change

The first oil change should be carried out after approximately **50 operating hours**, then every year or after 500 operating hours.

New oil: 0.8 l

Kränzle High Performance Gear Oil (Item no.: 400932)



Oil change must be performed by a specialist!



Oil leakage

If oil leaks contact your nearest after-sales service (dealer) at once. Failure to observe this instruction may cause damage to the environment and/or transmission gearbox.



In case of increased humidity or fluctuations in temperature development of condensed water is possible. If the oil turns grey or white, you must change it.

Decalcifying

Calcified heat exchanger use an unnecessary amount of energy because the water can only be heated slowly and the excess pressure valve feeds a part of the water back into the high-pressure pump circuit.

The calcified heat exchanger is known by the increased pipeline resistance.

Check pipeline resistance by disconnecting the lance from the trigger gun with safety catch and switching the high-pressure cleaner on. A full jet of water emerges from the gun. The high-pressure cleaner must be decalcified if the pressure shown on the stainless steel pressure gauge is **greater than 50 bar**.

Decalcify high-pressure cleaner as follows:

1. Decouple the lance from the trigger gun with safety catch and decalcify it separately.
2. Set high-pressure cleaner at the main switch on "ON".
3. Hold the gun in a separate container and press the trigger gun with safety catch.
4. Wait until descaling agent escapes at the trigger gun with safety catch (recognizable by whitish colour).
5. Switch high-pressure cleaner at the main switch on "OFF" and let descaling agent work for 15 - 20 minutes.
6. Switch high-pressure cleaner at the main switch on "ON" again and rinse it for two minutes using clear water.
7. Please check whether the flow resistance has a lower value now again. If necessary, please repeat the decalcification process.



Decalcifiers are caustic! Observe the instructions for usage and accident prevention. Wear protective clothing to prevent the decalcifying agent from contacting your skin, eyes and clothing.

Thermostat

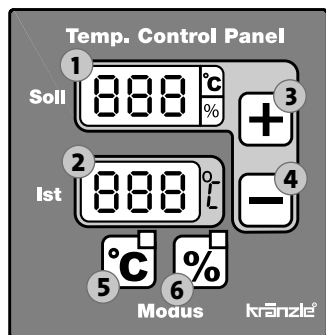

The thermostat controls the spray water temperature. After you switch on the device, "888" appears in both displays for approx. 1 second as a test of the functioning of the displays.

The thermostat has two operating modes:

1. Temperature mode

This mode is always activated when the unit is switched on or can be selected using the "°C" button (Pos. 5). The red LED above the "°C" button and next to the set temperature display lights up.

The desired "Set" temperature is set using the two buttons (+/-, Pos. 3+4) and can be read in the upper display (Pos. 1). If you press the button for a longer time, the set temperature is quickly adjusted in 5 °C increments.

The last set value set is also stored after the unit is switched off and is available again immediately after switching back on. The current spray temperature can be read from the bottom display (Pos. 2)

2. Percentage mode

This mode is activated by pressing the "%" button (Pos. 6). The yellow LED above the "%" button and next to the set temperature display flashes.

In the temperature control of high-pressure cleaners in temperature mode ("°C"), the water temperature is measured at the outlet of the heater, and the heater is switched on an off according to the temperature desired by the user. Due to the large amount of water in the heating coil, it takes a long time until the temperature sensor registers that the burner has switched on and the desired temperature has been reached.

This means that the temperature increases far above the desired value or falls far below the desired value. The innovative new percent mode now lets the user specify the switching duration of the heater in percent using the "+" and "-" buttons (Pos. 3+4) (100% being the max. temperature) rather than setting the desired temperature. Now the result of the setting must be checked by using the "Actual" temperature display. If the desired temperature has not yet been reached, the percentage must be increased.

By setting percentages of the heating duration, the temperature of the high-pressure jet is kept constant in a very narrow range. The last value set is also saved after the unit is switched off in percent mode.

Operating hour meter

The cleaner is equipped with an operating hour meter. If during normal operation the momentary operating mode button ("°C" or "%") is actuated for more than 2 seconds, the operating time of the pump is displayed for 5 seconds and afterwards the combustion time for 5 seconds as well. Thereafter the display shows the original values again. As long as the operating hours are displayed no further inputs on the monitor are possible.

The operating time is displayed in hours [h] either in the "TARGET" or in the „ACTUAL“ window. The 1000 and 100 hours are displayed in the „TARGET“ window and the 10, 1 and 1/10 hours in the "ACTUAL" window:

Pump operating time: Target-Display: P 9 9 Actual-Display: 9 9. 9 for 9 999,9h
 Combustion time: Target-Display: F 9 9 Actual-Display: 9 9. 9 for 9 999,9h

e.g.: F00 27.3 = Combustion time 27 hours and 18 minutes

Was Sie unbedingt beachten müssen: Problem Wassermangel

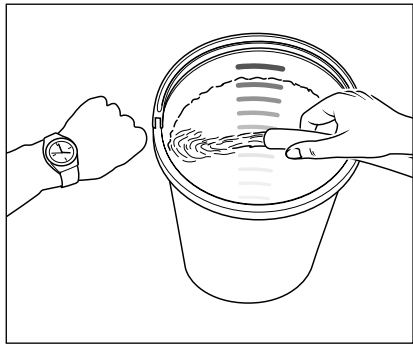

Lack of water occurs more often than you probably believe. The more powerful a high-pressure cleaner is the greater is the danger that a lack of water occurs. If there is only an insufficient amount of water available, cavitation (water-gas mixture) arises inside the high-pressure pump, which is normally noticed too late or even not at all. **The high-pressure pump will be destroyed.** Please check the available quantity of water by filling a bucket with liter scale for one minute.

Required minimum quantity of water (see technical data).



If the metered quantity of water is too small, you have to use a different water connection, guaranteeing the necessary output. Lack of water leads to an accelerated wear of the joints (no warranty).



Never let the high-pressure pump run dry for more than 60 seconds.

Water supply



Please pay attention to the regulations of your waterworks company! In accordance with DIN EN 61770, the high-pressure cleaner may not be directly connected to the public drinking water supply lines. A brief connection however is permissible according to DVGW (German Association for Gas and Water Affairs) if a non-return valve with tube ventilator (Kränzle item no.: 410164) is built into the water supply. **Once the water has passed through the non-return valve it is no longer considered as drinking water.** Also indirect connection to the public drinking water supply lines is permissible by way of free emission in accordance with EN 61 770; e.g. by using a reservoir with a float valve. Direct connection to a non-drinking water supply line is permissible.

Insufficient quantity of electricity

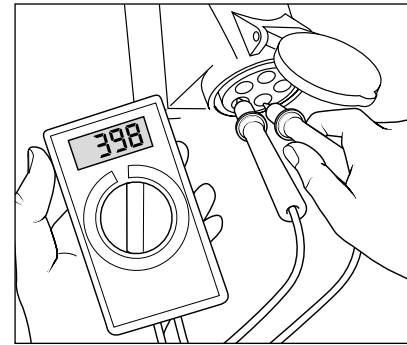

If there are too many collectors in your proximity connected to the network at the same time, the available voltage and the current intensity may decline. Consequently the motor of the high-pressure cleaner does not start or even blows. The power supply cable may also be insufficient if the power supply cable is too long or too thin. If extension cables are too long, this may lead to a voltage drop causing malfunctions or start-up difficulties.



Check the line fusing and have the voltage and the available current intensity checked by an expert in case of uncertainty (see technical data).

Electrical connection

The voltage indicated on the rating plate must match the voltage from the power source. The high-pressure cleaner is supplied with a power supply cable. The mains plug must be fitted to a standard grounded socket with a **30 mA** residual current operated device. Connection up to the mains must be carried out by a properly trained electrician and must comply with the requirements of IEC60364-1.

The socket is to be protected on the mains side according to the specifications (see technical data in the spare parts list). When using an extension cable, this must have an earthed lead which is properly connected to the socket. The conductors of the extension cable must have the following minimum cross-section:

at 18 kW: 6 mm²
 at 24 kW: 10 mm²
 at 36 kW: 16 mm²
 at 48 kW: 25 mm²



If extension cables are too long, this may lead to a voltage drop causing malfunctions. When using a cable drum, always keep the cable wound as far as possible.

Water and cleaning system (e-therm 500 M 18)

Water must be supplied to the high-pressure pump under pressure or directly sucked in out of a pressureless container. The water is then forced under pressure by the high-pressure pump to the lance. The high-pressure jet is formed by the nozzle at the end of the lance.

Water and cleaning system (e-therm 500 M 24 – e-therm 873 M 48)

Water can be connected at mains pressure to the high-pressure pump. A float valve in the water tank regulates the water inlet. Then, the water is sucked by the high-pressure pump from the water tank and supplied to the lance under pressure. The high-pressure jet is formed by the nozzle at the end of the lance. Bypassing the water tank water can also be sucked directly out of a pressure-less container (see direct suction).



Environmental, refuse disposal and water protection regulations must be observed!

Safety jet pipe with safety trigger gun

The high-pressure cleaner can only be operated when the trigger of the safety deactivation trigger gun's trigger is actuated. When the trigger is pulled, the safety trigger gun opens. The liquid is then transported to the nozzle. The spray pressure increases and quickly reaches the operating pressure. When the trigger is released, the safety trigger gun closes and any further spraying of liquid from the safety jet pipe is prevented. The increase in pressure when the safety trigger gun is closed causes the pressure control valve-safety valve to open. The motor is switched off by the pressure switch. When the safety trigger gun is opened, the pressure control valve/safety valve closes, the motor is started and the high-pressure pump resumes pressure spraying from the safety jet pipe with the selected operating pressure.



The safety trigger gun is a safety device. Repairs should only be performed by qualified persons. Should replacement parts be required, use only components authorized by the manufacturer.

Pressure control valve/safety valve

The pressure control valve/safety valve protects the high-pressure cleaner from a build up of excess pressure, and is designed not to permit an excess pressure to be selected for operation. The limit nut on the handle is sealed with a spray coating. The operating pressure and spray rate can be steplessly adjusted by turning the handle.



Replacements, repairs, new adjustments and sealing should only be performed by qualified persons.

Motor protection switch

Motor is protected against overload by means of a motor protection switch. In case of motor overload or blocking, the motor of the high-pressure cleaner switches off automatically. If motor tends to switch off repeatedly, make sure to detect and remedy the cause of the failure.



Replacements and inspection work should only be performed by qualified persons **when the high-pressure cleaner is disconnected from the power supply**, i.e. with plug pulled out from the electrical socket.

Total stop system with delayed motor cut-off

When opening the trigger gun the motor is started via a total-stop system. **When closing the trigger gun the motor is switched off only after 38 seconds and the device is in standby mode.** The delayed switch-off is necessary because switching on and off motors frequently on high-pressure cleaners of this size may involve heavy load on the power network and cause increased wear of internal electrical parts. After 20 minutes in standby, the device will disconnect from the mains and must be turned on again by the main switch. The machine restarts automatically when the gun is re-opened, provided that the master switch is on.

Safety shutdown

If the high-pressure cleaner is accidentally not turned off after use or the trigger gun with safety catch is not used for 20 minutes, the high-pressure cleaner automatically changes into safety state by deactivation. By operating the main switch once more, the device is activated again.

High-pressure hose and spray device

The high-pressure hose and spray device which are part of the e-therm-series equipment, are made of high quality material and engineered to conform with the operating conditions of the high-pressure cleaner and are duly labeled.



If replacement parts are required, only such parts that are authorized by the manufacturer may be used. The warranty is automatically void if spare parts of third-party providers are used! The high-pressure hose and spray device must be connected in a pressure-tight manner (without leakage).



The high-pressure hose may not be driven over, pulled excessively, or twisted. The high-pressure hose may under no circumstances be pulled over sharp edges. Defective high-pressure hoses must not be repaired (acc. to DIN 20022) but have to be replaced by new hoses approved by the manufacturer.



Prior to putting the high-pressure cleaner into operation make sure that all safety instructions be observed.

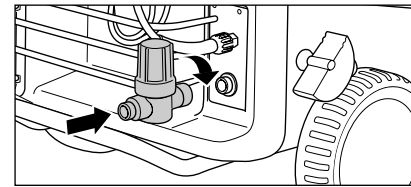

1. Install the water inlet filter (available as an option) at the water inlet.

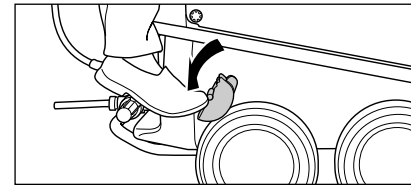

2. For moving the high-pressure cleaner to the place of use, please release locking break. The high-pressure cleaner must not be pulled with connected water supply hose!

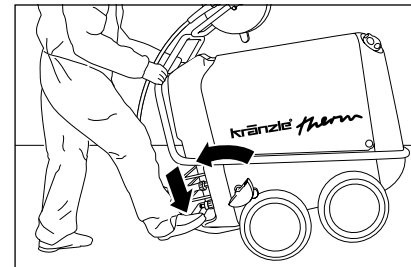

3. The e-therm-series is a movable high-pressure cleaner with sturdy trolleys ideally suited for difficult terrain. For steering the high-pressure cleaner put the foot against the tipping support and then pull the device towards you.



Neither set up or operate the e-therm-series in rooms where there is a risk of fire or explosion nor put it into puddles. Do not use the high-pressure cleaner under water. If, none the less, the high-pressure cleaner is operated in a hazardous area, the applicable safety regulations are to be observed.

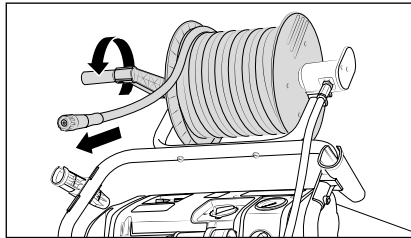

4. For high-pressure cleaners with hose drum, please loosen the fixation and then completely unwind the high-pressure hose. For high-pressure cleaners without hose drum the high-pressure hose included in the scope of the delivery must be screwed with the pump outlet in a tight and pressure tight manner. Unwind high-pressure hose straight and without nooses. The high-pressure hose may leave signs of abrasion on some floors. Alternatively, please also find non-marking high-pressure hoses in our range.

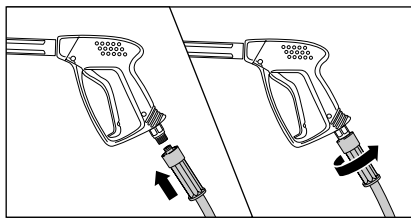
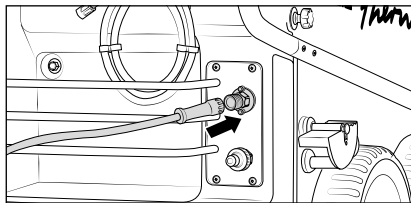

5. Mount the grey rotating screw connection of the high-pressure hose onto the trigger gun incorporating a safety catch. Afterwards screw together ensuring a snug and pressure-tight fit.

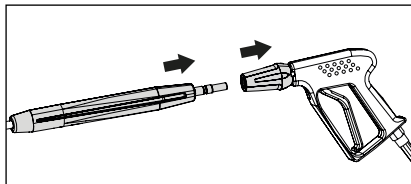

6. First pull back the retaining sleeve of the safety trigger gun, then insert lance into the plug coupling connection of the safety trigger gun.

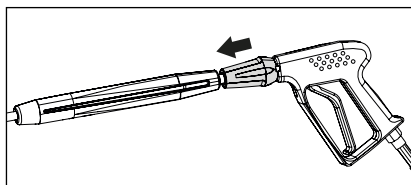

7. After insertion of the lance, release retaining sleeve and make sure that the lance is in a secure position.
Grease quick release nipple regularly using acid-free grease.

! During operation, the plug-in coupling must not be operated/touched! High risk of injury!



Prior to insertion, check plug coupling connection of lance for cleanliness (sand, dirt ..) and use clear water to clean, if necessary. Impurities may damage the sealing in the plug coupling.



When using high-pressure hose extensions take care that the max. length of 20 m is not exceeded!



Accessories may only be connected to a Kränzle-approved trigger gun with safety catch.

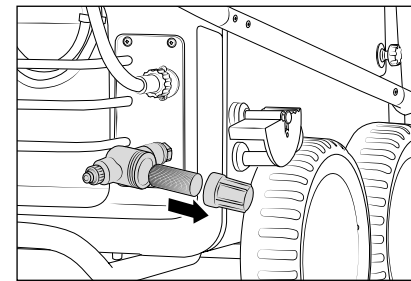

8. **Check water inlet filter for cleanliness prior to putting the high-pressure cleaner into operation.**

Unscrew the filter cup manually, take out the water inlet screen, flush thoroughly and clean with the remaining parts under clear water. If the screen is dirty, no water can run through and no pressure can build up.



Check the water inlet sieve for damage. Do not operate the high-pressure cleaner without or with a damaged filter.

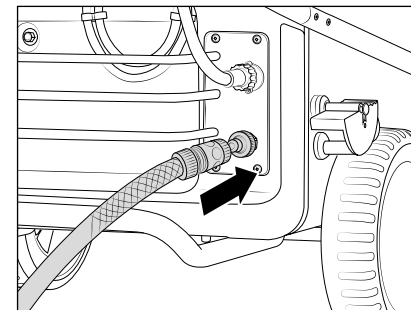

9. Connect water hose to water inlet (minimum requirements; 5 m hose length, cross-section 3/4", 10 bar). The high-pressure cleaner may be connected to a water mains (1-10 bar pre-pressure) with either cold or hot water (up to 60 °C). The e-therm-series provides the opportunity of sucking in water out of a container (see direct suction).



Be careful when using hot water!

When running your high-pressure cleaner with hot water of 60 °C raised temperatures occur. Do not touch the metal parts of the high-pressure cleaner without safety gloves!

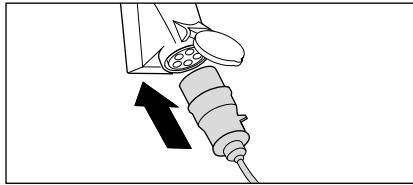

10. Connect to circuit (see technical data).



Do not touch the mains plug or any live parts with wet or moist hands.

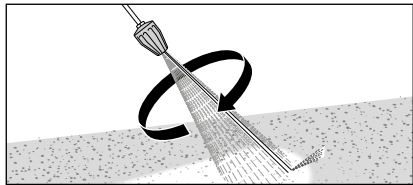

11. When using the turbokiller (available optionally), ensure that the lance is pointing down for start-up.



Prior to putting the high-pressure cleaner into operation make sure that all safety instructions be observed.

Usage as a cold water high-pressure cleaner

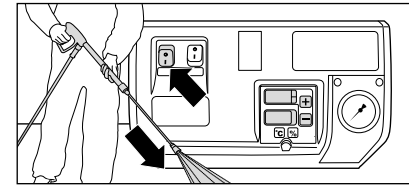

1. Switch on high-pressure cleaner with opened trigger gun (trigger pulled). Bleeding of the high-pressure cleaner: Pull and release trigger of trigger gun with safety catch several times. Start with cleaning process.



2. When starting the cleaning process do **not** aim the water jet towards the object you want to clean for at least 30 seconds. Maybe the water inside the combustion chamber has changed colour due to the rest time.

Usage as a hot water high-pressure cleaner

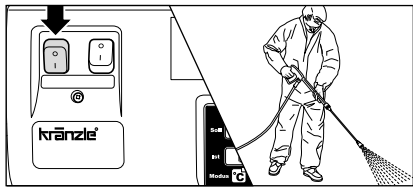

1. Hochdruckreiniger bei geöffneter Sicherheits-Abschalt pistole einschalten. Den Hochdruckreiniger entlüften: Sicherheits-Abschalt pistole mehrmals öffnen und schließen.

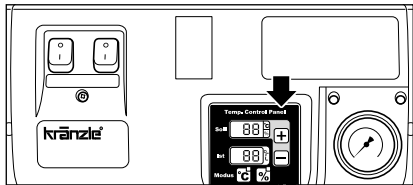

2. Set desired temperature at the thermostat. (Min. temperature 40 °C). On the subject of thermostat settings, see chapter "Functional details" in these operating manual.

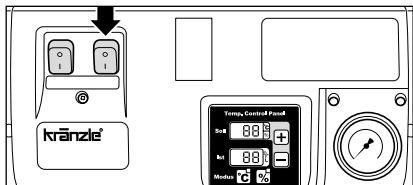

3. Switch on heater switch. The water is heated up and constantly kept at the set temperature.

Start with cleaning process.



During high-pressure operation (above 30 bar) the temperature may not exceed 90 °C.

Direct water extraction

Due to the suction capacity of its high-pressure pump (up to 2.5 m suction height, max. hose length 3 m) this high-pressure cleaner can suck in water for cleaning purposes from separate containers or ponds. In this case the water tank must be bypassed.

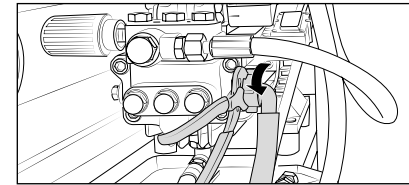

1. Unscrew connecting hose between high-pressure pump and water tank.

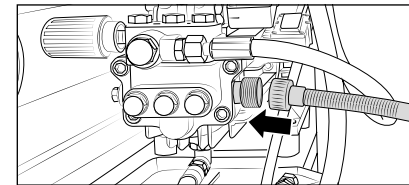

2. Screw suction hose with suction filter (Item.-no.: 150383) with connecting hose using a spreaded steel pipe fitting (Item.-no.: 46004).

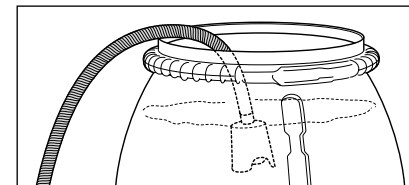

3. Put filled suction hose into the water-filled container and start the cleaning job.

**Use clean water only!
Never suck in water containing chlorine! Do not suction air!**



Prior to starting the first suction the high-pressure pump and the suction hose has to be filled with water!

Note

Depending on the water quality it may occur after a prolonged standstill that the valves get sticky. Consequently the high-pressure cleaner cannot properly suck in water from a container. In this case connect a hose with pressurized water to the pump inlet. Having started the high-pressure cleaner the pressurized water opens the valves and the machine resumes sucking in water from the container. Now you can carry on with your cleaning task as usual.



1. Switch off the high-pressure cleaner
2. Cut off the water supply
3. Open the safety trigger gun catch briefly until the pressure is released
4. Apply safety catch on the trigger gun
5. Remove high-pressure hose and safety trigger gun
6. Emptying high-pressure pump: Hold high-pressure hose and switch motor on until water jet stops escaping at the outlet.
7. Pull the plug from the socket
8. Clean high-pressure hose and wind up without loops, fix hose drum
9. Clean and wind up the power supply cable
10. Clean the water inlet sieve
11. Apply locking brake
12. Store high-pressure cleaners in frost-free rooms in winter

Frost protection (e-therm 500 M 18, e-therm 500 M 24)

For protecting the high-pressure cleaner against frost please empty it completely. Separate high-pressure cleaner from water supply and switch it on. By opening the safety trigger gun the high-pressure pump presses water out of the water tank. **However, do not allow the high-pressure cleaner to operate without water for more than one minute.**

Frost protection (e-therm 603 M 36, e-therm 873 M 48)

For protecting the high-pressure cleaner against frost please empty it completely. Separate high-pressure cleaner from water supply and switch it on. By opening the safety trigger gun the high-pressure pump presses water out of the water tank. **However, do not allow the high-pressure cleaner to operate without water for more than one minute.** Fill the anti-freeze agent into the water box and turn on the high-pressure cleaner. Wait with opened gun until the agent spurts out of the nozzle.

Inspections performed by Kränzle

- Measurement of earth line resistance
- Measurement of voltage and current
- Inspection of tension consistency with +/- 1530 V
- Pressure check of heating coil at 300 bar
- Visual and functional check as per the inspection sheet provided
- Exhaust fume analysis (see test strips provided)

Guidelines for liquid sprayers

The machine conforms with the "Guidelines for liquid sprayers". These guidelines are issued by the organisation of trade associations and may be obtained from Carl Heymann-Verlag KG, Luxemburger Str. 49, 50939 Köln. These guidelines specify that this machine is to be inspected by qualified personnel whenever necessary, but no less than once every 12 months. These inspections must be recorded in the inspection log at the end of this manual.

Duties of owner

The owner is to ensure that all safety-relevant components are in a serviceable condition before the sprayer is used. (e.g., safety valves, hose and electric cables, spray equipment etc.)

Yearly, or after approx. 500 hours of operation:

- Check flow heater for scale, descale if necessary.
- Change the oil See chapter „General rules“ in these Operating Instructions.



The machine must be disconnected from the power supply when servicing work is being carried out. The main switch should be in position "0" and the plug out of the socket.

Problem

No water from nozzle although the high-pressure cleaner is running.
The stainless steel pressure gauge shows full pressure.

Cause

Most likely the nozzle is blocked.

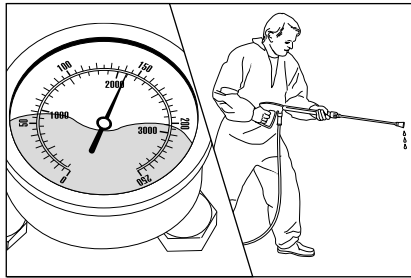

The stainless steel pressure gauge shows full pressure, but from the nozzle comes only little water or no water at all.

(Inside the stainless steel pressure gauge is no water but a filling with glycerin to damp the vibration of the pointer.)

Proceeding:

Switch off the high-pressure cleaner. Pull plug from the socket. Operate safety trigger gun catch several times to decrease the pressure.

First remove the trigger gun with safety catch and the lance and flush the high-pressure hose clear of potential residues. Check water inlet filter for soiling.

If the problem still exists, take wire (paper clip) and push through nozzle opening. If this procedure is not successful, the nozzle has to be replaced.

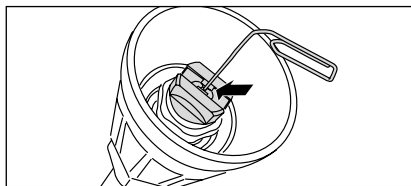

Pull plug from socket prior to starting any repair work!

Problem

Irregular jet from nozzle.
The stainless steel pressure gauge shows low pressure.

Cause

Most likely the valves are soiled or sticky.

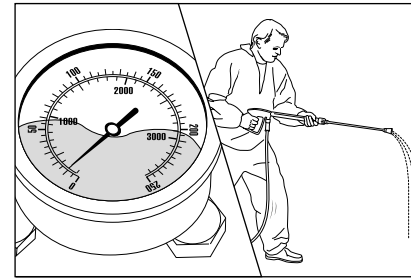

The stainless steel pressure gauge shows low pressure despite fully turned up pressure regulation. The water from the lance comes in squirts. The high-pressure hose vibrates.

(Inside the stainless steel pressure gauge is no water but a filling with glycerin to damp the vibration of the pointer.)

Proceeding:

Unscrew all 6 valves, one after the other (hexagonal brass screws, 3 in a row, vertically and horizontally)

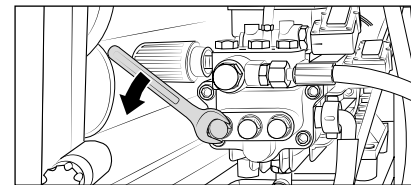

Take out valve body and O-ring by means of needle nose pliers. Check O-ring for damage. In case of a damage the O-ring has to be replaced.

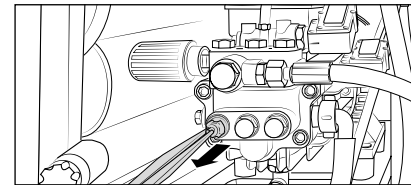

Take a wire (paper clip) and clean valves under running water.

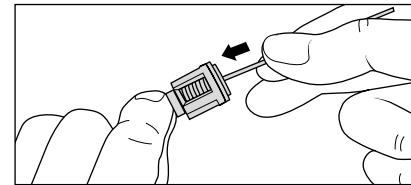

Do not forget the O-ring during reassembly!

Problem

After closing the safety trigger gun the high-pressure cleaner keeps switching on and off.
The stainless steel pressure gauge continuously displays full pressure.

Possible cause No. 1

Leakage.

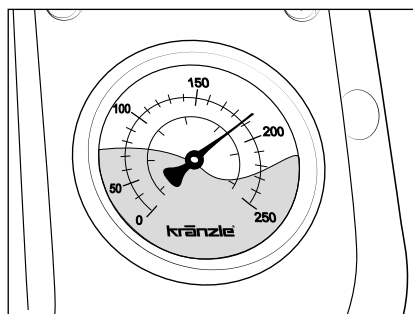

Having closed the trigger gun with safety catch, the high-pressure cleaner must shut down and the stainless steel pressure gauge must show the permitted deactivation pressure (see rating plate). If not shut down and the stainless steel pressure gauge continuously shows full pressure (device does not switch to bypass), this could be due to leakage at the high-pressure pump, at the pressure switch, at the high-pressure hose or at the trigger gun with safety catch.

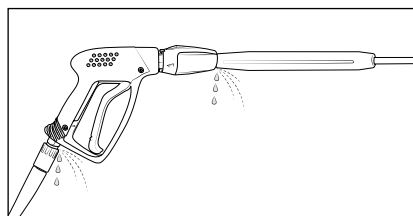

Proceeding:

Check connections from the high-pressure cleaner to the high-pressure hose and from the high-pressure hose to the safety trigger gun and also the connection between lance and safety trigger gun for tightness.

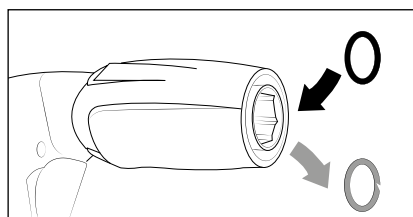

Switch off the cleaner. Shortly press the trigger of the trigger gun with safety catch to decrease the pressure. Remove high-pressure hose, trigger gun with safety catch and lance and check the O-rings. If the O-rings are damaged they have to be replaced.



In case of a leakage there is no guarantee for possible consequential damages.

Problem

After closing the safety trigger gun the high-pressure cleaner keeps switching on and off.
The stainless steel pressure gauge continuously displays full pressure.

Possible cause No. 2

The non-return valve is defective.

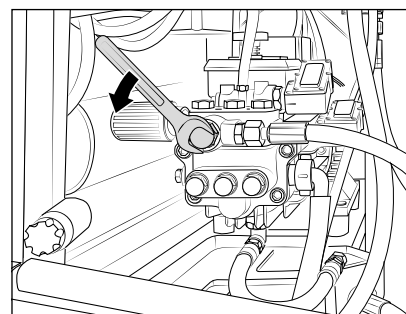

Proceeding:

Switch off the high-pressure cleaner and pull plug from socket. Stop water supply. Operate safety trigger gun catch several times to decrease the pressure. Unscrew pump outlet.

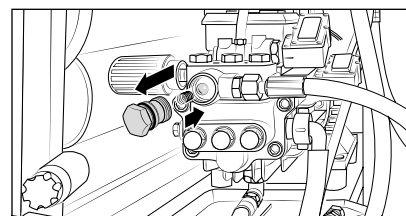

Remove check body and check O-Ring for soiling or damage. Also check seal seat inside pump housing for soiling or damage.

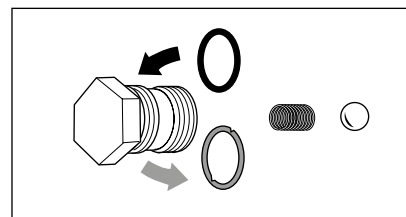

If sealing rings are defective replace O-rings at once.



There is no guarantee if the high-pressure pump is damaged by defective O-rings due to air induction or lack of water (cavitation).

Summary of additional causes of malfunction

Problem Possible cause

Water supply

Water tank runs over	Float valve is dirty/defect
Water tank does not fill completely	Float valve is defect, water inlet filter dirty, water intake too low
High-pressure pump does not suck	Valves sticky or are dirty, suction hose leaks, detergent valve is open or leaks, Check hose connections, high-pressure nozzle is clogged
Test: Check water suction system for tightness	Connect water inlet directly to the high-pressure pump (2-8 bar pre-pressure). Disconnect suction lines below the high-pressure pump.

High-pressure pump

High-pressure pump makes lots of noise. Operating pressure is not reached	High-pressure pump sucks air, check suction connections and high-pressure nozzle, check O-rings and valves, check sleeves. Unloader: Check stainless steel seat and ball. Check seals on the control piston.
Water drops from the high-pressure pump	Replace sleeves in the high-pressure pump. Replace O-rings.
Pressure is too low	High-pressure nozzle washed out, stainless steel seat, ball, O-ring in unloader is dirty or defect.



In case of repeated malfunction or should you be incapable of resolving it by yourself, please contact our customer service.



Pull plug from socket prior to starting any repair work!

Oil drops from the transmission	Check/replace oil seals. Check plunger and plunger guides.
---------------------------------	---

High-pressure cleaner start/stop

High-pressure cleaner does not switch off	Check return body and O-ring in unloader of the valve housing.
Test: Jumper pressure switch	Check pressure switch, check micro switch, check cable connections.
High-pressure cleaner does not start or stop during operation	Check electricity supply, check main switch, check cable connections, board is defect. Switch off by overcurrent release. Check micro switch.
High-pressure cleaner does not	Check electricity supply, check main switch, check cable connections. Switch off by overcurrent release. Check micro switch.

Leakage

Trigger gun with safety catch drips	Gun defective. Let repair.
High-pressure hose drips	Replace seals. Replace O-ring under screwed connection.
Stainless steel pressure gauge shows pressure but no water comes out	Clean high-pressure nozzle

Displayed malfunctions

Display in the field		Cause	Action
Soll	Ist		
Err	OFF	Water temperature at heating chamber outlet above 100 °C	Operate appliance without heating „Heating OFF“ until the temperature has dropped below 100 °C. Switch main switch „OFF“ and then back „ON“ again.
Err	E2	Temperature sensor defective	Replace temperature sensor
Err	E5	Flow monitor does not respond. Magnetic switch or flow controller defect.	Replace defective magnetic switch or flow body.
Err	E6	Black pressure switch does not respond	Replace pressure switch mechanics or micro switch.
AUS	E7	Appliance has not been operated for more than 20 minutes → Safety cut-off	Switch main switch „OFF“ and then back „ON“ again.
UES	Ist-Wert	Overload protection of motor high-pressure pump is actuated	Check energy supply, Remove extension cord, Nozzle clogged? Use master switch „OFF“ / „ON“ to switch off or on.

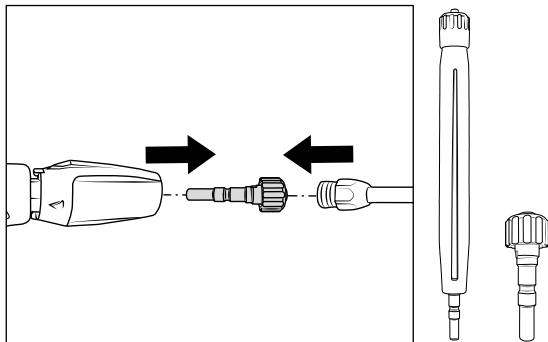

Adapter for accessories with screw connections

- With quick release nipple
- 400 mm extension
- With grip plates

For item no.: 12440 (fig. left)

■ 400 mm extension

■ With grip plates

Item no.: 12440 (fig. left)

Item no.: 12441 (fig. right)

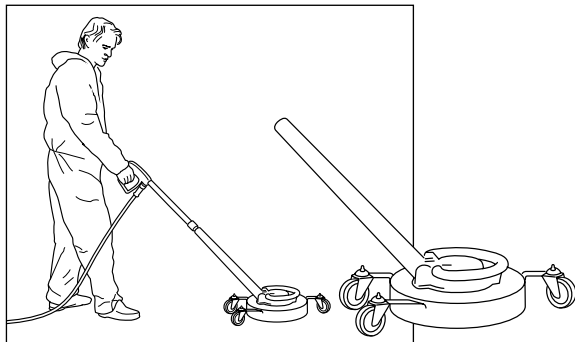

Floor washer Round Cleaner UFO lang (stainless steel) *

- From stainless steel
- Ø 350 mm
- Nozzle system 045

* in combination with adapter only

Item no.: 41861

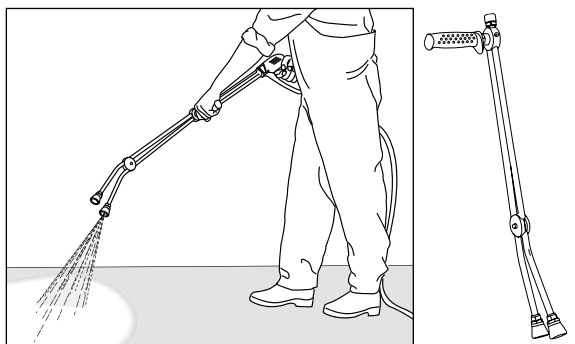

Double lance

- With insulated ISO handle
- With plug-in nipple
- Low pressure nozzle D3035 as standard

Item no. double lance: 12133

Order nozzle separately:

e-therm 500 M 18, 24: D2503

e-therm 603 M 36: D2504

e-therm 873 M 48: D2505

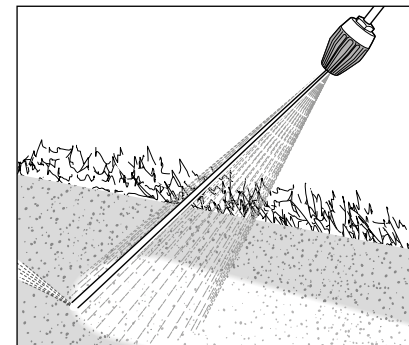

Turbokiller lance

- With stainless steel pipe
- 1000 mm
- With plug-in nipple

Item no.: 12430-045

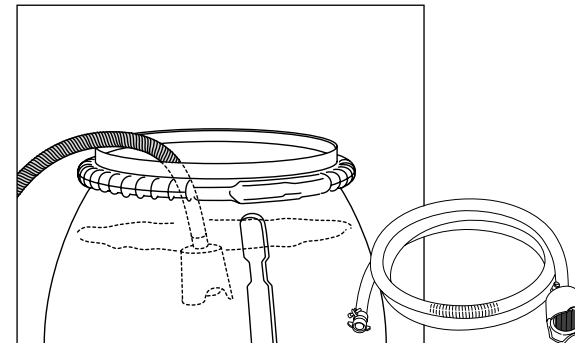

Suction hose with suction filter

- With return valve
- Hose length 3 m

Item no.: 150383

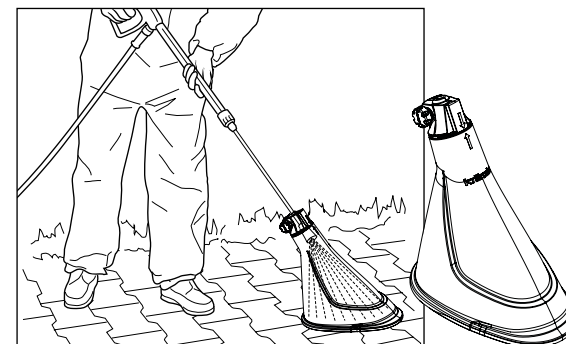

Splash guard

- L: 280 mm x W: 190 mm
- For all washing lances

Item no.: 132600



The high-pressure cleaner accessories are safety components!
Any warranty will be void if parts not authorised by Kränzle are used.



Please indicate the technical data of the high-pressure cleaner (device type) when placing your order.

We here by declare that the design of the high-pressure cleaners:

e-therm 500 M 18
e-therm 500 M 24
e-therm 603 M 36
e-therm 873 M 48

Nominal flow:

e-therm 500 M 18: 480 l/h
e-therm 500 M 24: 480 l/h
e-therm 603 M 36: 600 l/h
e-therm 873 M 48: 780 l/h

technical specifications available from:

Fa. Josef Kränzle GmbH & Co. KG
Manfred Bauer
Rudolf-Diesel-Str. 20, 89257 Illertissen

comply with the following guidelines and their amendments for high-pressure cleaners:

Machinery Directive 2006/42/EC
EMC Directive 2014/30/EU
ROHS Directive 2011/65/EU
Outdoor Directive 2000/14/EC

Noise pressure level, typical:
 Noise pressure level, guaranteed:

84 dB (A)
86 dB (A)

Applied conformity assessment procedure:

Annex V, Outdoor Directive 2000/14/EC

Applied specifications and standards:

EN 60335-1: 2012/A13: 2017
EN 60335-2-79: 2012
EN 62233: 2008
EN 55014-1: 2006+A1: 2009+A2: 2011
EN 55014-2: 2015
EN 61000-3-2: 2014
EN 61000-3-3: 2013

Josef Kränzle GmbH & Co. KG
 Rudolf-Diesel-Straße 20
 89257 Illertissen (Germany)

Illertissen, 2019-04-05

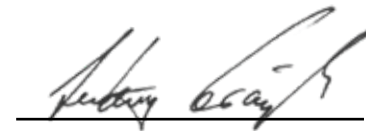

Ludwig Kränzle
 (Managing director)

The warranty obligation of Josef Kränzle GmbH & Co. KG towards the dealer from whom you have purchased this Kränzle high-pressure cleaner (= product) applies to material faults only such as material and manufacturing defects.

Defects attributable to long and frequent use of the product, typically arising due to the age of the high-pressure cleaner and intensity of its use are defined as normal wear in respect of product components. Purchaser's rights to assert claims for such defects are ruled out. Parts subject to wear include in particular the pressure gauge, nozzle, valves, sleeves, high-pressure hose and spray equipment.

The product is to be operated in conformity with this operating manual. The operating manual is deemed to be part of the warranty provisions.

Any changes made to the safety devices of the product or instances of maloperation – such as exceeding the temperature and speed limits, undervoltage, insufficient water supply and sewage water, or failure to use the product for the intended purpose – may result in damage occurring to the product. Such damage is not deemed to constitute any material defect.

Should the use of accessories or spares other than original Kränzle component parts and original Kränzle replacement parts be the cause of defects on our product, this may lead to all warranty claims becoming null and void. Only the use of original Kränzle replacement parts matching the relevant Kränzle high-pressure cleaner provides adequate assurance for safe and trouble-free operation of the Kränzle high-pressure cleaner.

With regard to legal warranty claims, the limitation periods of the respective countries shall apply.

Where warranty claims apply to any other defects, please contact your local dealer, presenting the accessories together with your purchase receipt, or the nearest authorised service centre. This can also be found on the internet under **www.kraenzle.com**.

High-pressure cleaners for industrial use have to be checked by an expert every 12 months!

Inspection report on annually carried out Labour Safety Inspection (UVV) according to the Guidelines for Liquid Spray Equipment. (This inspection sheet serves as proof for the completion of the retest and must be kept carefully!)

Kränzle-test seals: Item no.: UVV200106

Owner: Type:
 Address: Serial no.:
 Repair order no.:

Scope of inspection	o.k.	yes	no	repaired
Type plate (on hand)				
Operating manual (on hand)				
Protective covering, Protective device				
Pressure line (tightness)				
Stainless steel pressure gauge (function)				
Float valve (tightness)				
Spraying device (marking)				
High-pressure hose / connector (damage, marking)				
Safety valve opens at 10 % / 20 % exceeding				
Pressure reservoir				
Thermostat (function)				
Flow controller (function)				
Power supply cable (damage)				
Power plug (damage)				
Protective conductor (connected)				
On / Off switch				

Inspection data	determined value	set value
High-pressure nozzle		
Operating pressurebar		
Switch off pressurebar		
Protective conductor resistance not exceeded/value		
Insulation		
Leakage current		
Safety trigger gun locked		

Inspection result (check)

- The high-pressure cleaner was checked by an expert according to the Guidelines for Liquid Spray Equipment, the defects found have been rectified so that the Labour Safety can be confirmed.
- The high-pressure cleaner was checked by an expert according to the Guidelines for Liquid Spray Equipment. The Labour Safety cannot be confirmed unless the defects found are rectified by repair or replacement of the faulty parts.

The next retest according to the Guidelines for Liquid Spray Equipment has to be carried out by: Month Year
 Place, DateSignature

High-pressure cleaner (device type):

.....

- All lines connected
- Hose clamps tight
- Screws all installed and tightened
- Visual check carried out
- Brake function checked

Leak test

- Water tank filled and checked
- Water inlet checked for tightness
- Float valve function checked
- High-pressure cleaner checked for tightness under pressure

Electrical check

- Earth line checked

Current intake

Operating pressure
Cutting-off pressure

- Start/Stop automatic and re-run delay checked
- Thermostat function checked
- Heating checked for function

Water inlet temperature in °C

5	6	7	8	9	10	11	12	13	14	15
---	---	---	---	---	----	----	----	----	----	----

Water outlet temperature in °C

60	62	64	66	68	70	72	74	76	78	80	82	84	86	88	90
----	----	----	----	----	----	----	----	----	----	----	----	----	----	----	----

- Safety equipment sealed with lacquer
- The high-pressure cleaner fulfills all requirements according to this inspection sheet

Inspector:

Date:

Signature:

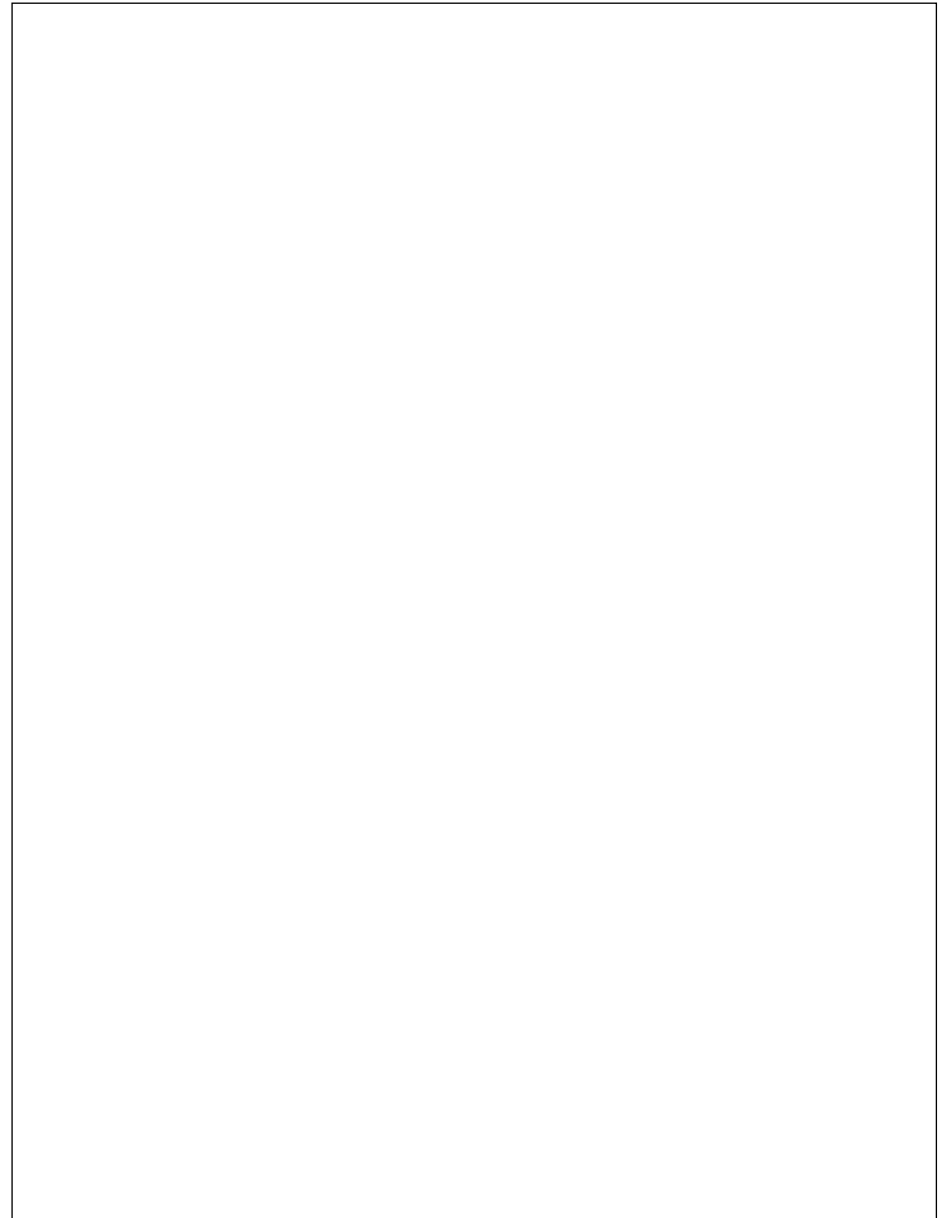
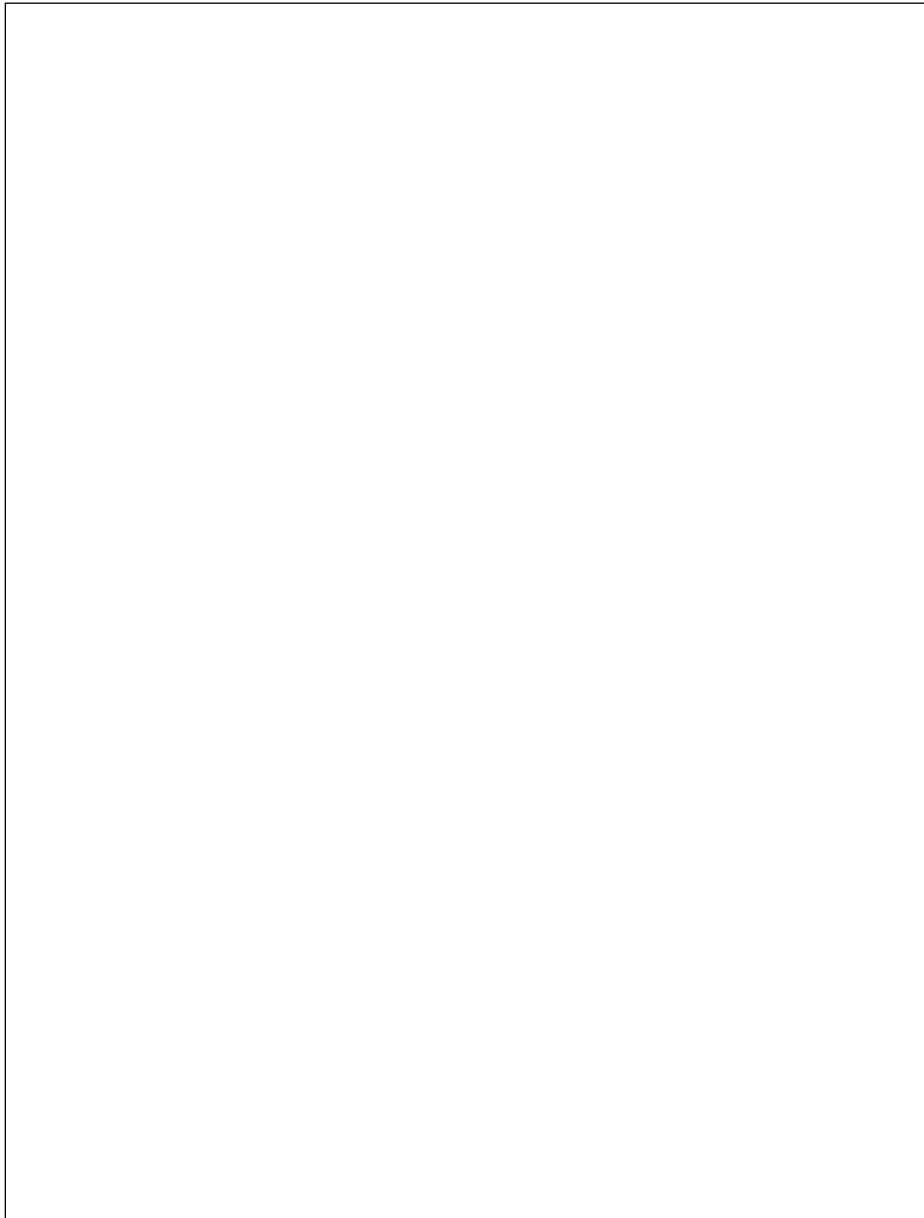



Josef Kränzle GmbH & Co. KG

Rudolf-Diesel-Straße 20
89257 Illertissen (Germany)

sales@kraenzle.com

© Kranzle 01.03.2021 / Ord.-no.: 307680 / Subject to technical modifications and errors.

■ **Made**
■ **in**
■ **Germany**